

3 601 M19 140

Issue } 14-07-03
Stand }

Fig./Abb. 5

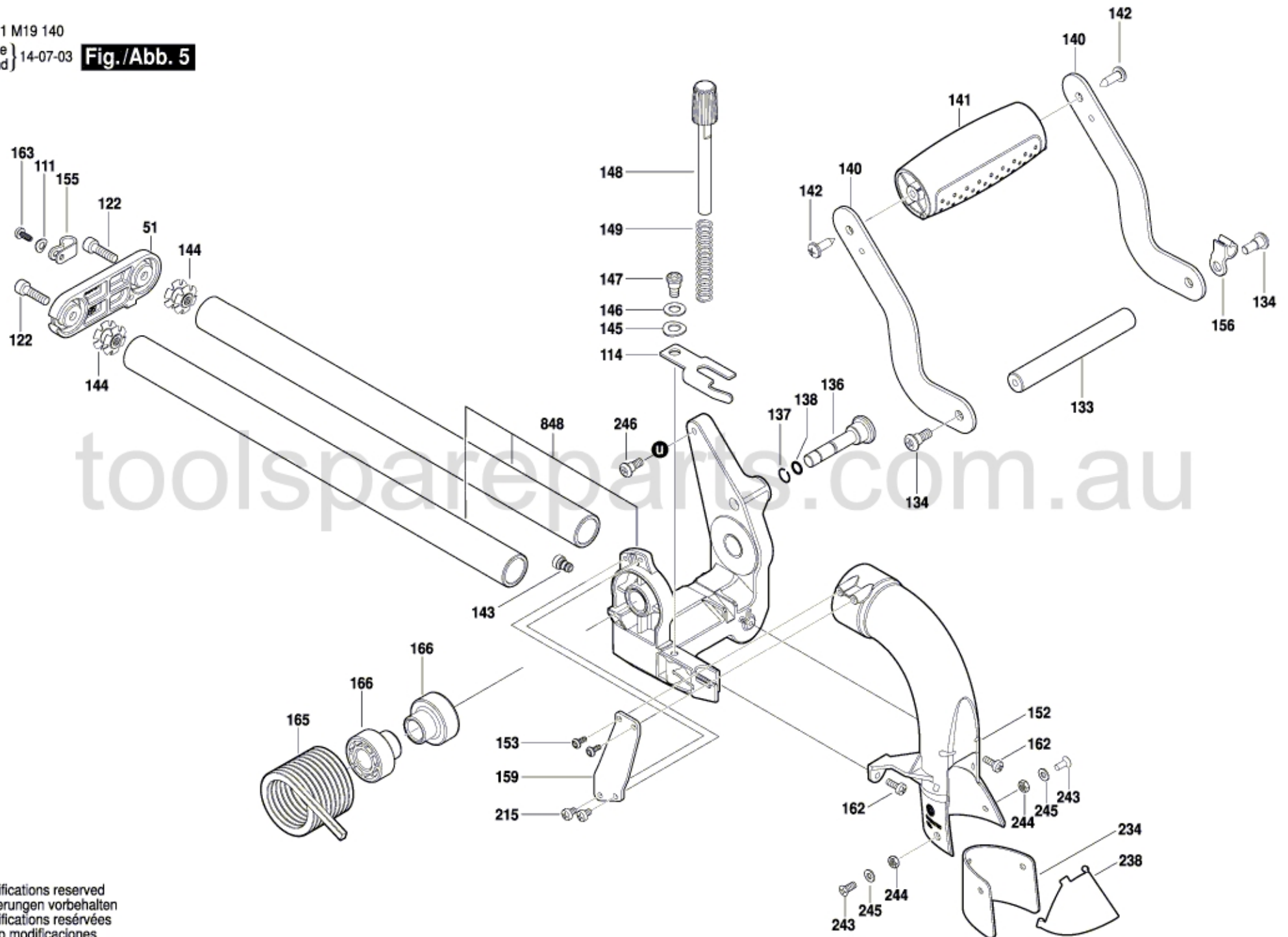

Modifications reserved
Änderungen vorbehalten
Modifications réservées
Salvo modificaciones